

Infrared Sensor Exit Button



Model: K1-1

Specification

- Size: 115Lx70Wx29H(mm)
- Input : DC12V
- Contact Rating: 12-28V,3A
- Output Contact: NO\NC\COM
- Mechanical Life: 500000 tests
- Suitable for Door: Hollow Door
- Operating temp: -20°C ~+55°C(14-131F)
- Suitable Humidity: 0-95% (relative humidity)
- Detection range: 0.1-10cm
- Weight: 0.18kg

Dimension Diagram

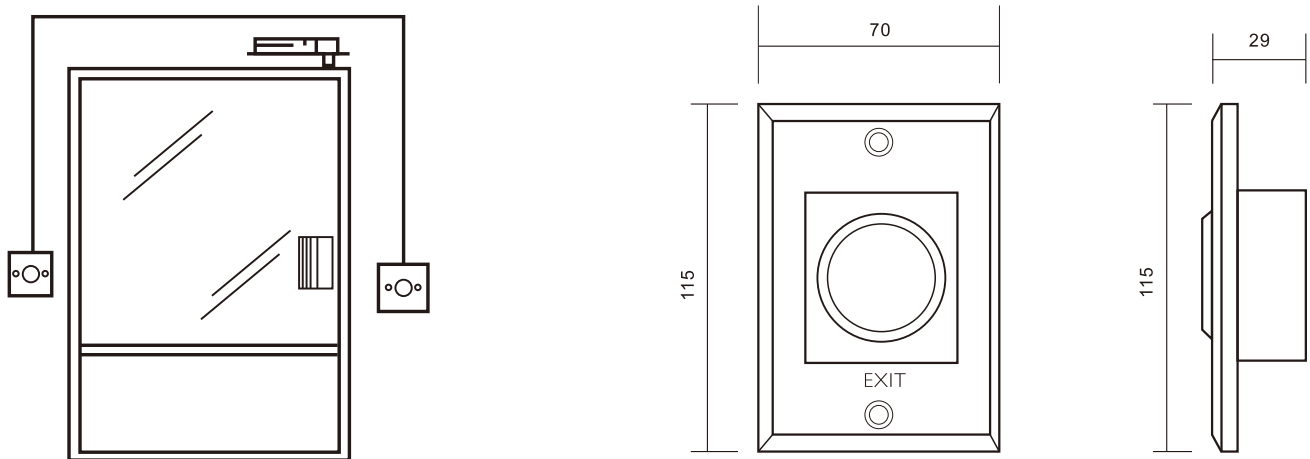

Installation

